



OLITE S-406T

STAINLESS STEEL
SINGLE BOWL KITCHEN SINK



DIMENSIONS

27" x 18" x 9"

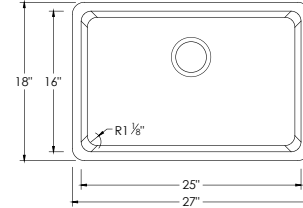
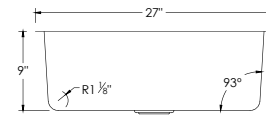

INCLUDED ACCESSORY



ST-05
STRAINER

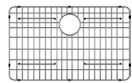

G-406
GRID

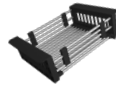

A-911
BASKET



A-916DG
DRYING MAT



A-904
CUTTING BOARD

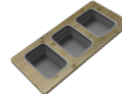

A-910
SERVING BOARD



A-913
CUTTING BOARD



A-900DG
DRYING RACK



S-01S
SOAP DISPENSER

RECOMMENDED ACCESSORIES

SURFACE FINISH

BRUSHED
SATIN FINISH

DRAIN HOLE SIZE



CORNER PROFILE



RADIUS 30mm

INSULATION

COATED +
RUBBER PADS

BOWL DEPTH



9"
SINGLE
BOWL

INSTALLATION OPTIONS



DROP-IN



UNDERMOUNT

MATERIAL

Premium 18 gauge stainless steel with 18/10 chrome-nickel content. The 18% of chrome content provides durability, maximum protection against rust and a beautiful satin finish. The 10% of nickel content provides excellent strength and hardness.



18 GAUGE
STAINLESS STEEL

PRODUCT DIMENSIONS

Overall Dimensions	27" x 18" x 9"
Internal Dimensions	25" x 16" x 9"
Left Basin	-
Right Basin	-
Drain Opening Size	3 1/2"

STANDARD STRAINER

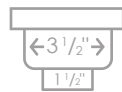

CABINET SIZE

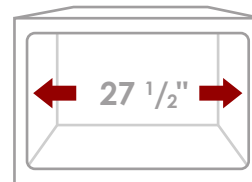

MINIMUM
INTERNAL SIZE

GARBAGE DISPOSAL

Stylish® sinks have on standard 3 1/2" drain opening that can fit any garbage disposal unit. The sink structure is well designed to withstand any heavy garbage disposal unit.



WARRANTY

This product is covered by a limited lifetime warranty. Consult our website for complete details.

PRODUCT CARE

Rinse and dry your sink with a clean soft cloth, working with, not a cross, the grain. We recommend the use of a mild solution of water and vinegar to remove any mineral deposits that may have built up on your sink.

Use mild non-abrasive liquid cream cleaners that do not contain chlorine, sodium hypochlorite or hydrochloric acid to help maintain the original appearance of your sink. Ensure that you thoroughly rinse your sink and wipe it dry. We recommend the use of a stainless steel grid that fits inside the bottom of the sink bowl and protect the sink from scratches.



STANDARDS COMPLIANCE

This sink meets cUPC standards. The ST-05 strainer is cUPC certified by the factory.

Stylish International Inc.

www.stylishkb.com

[stylish.international.inc](https://www.instagram.com/stylish.international.inc)

care@stylishkb.com

+1-855-789-5352



OLITE
S-406T

ÉVIER DE CUISINE À CUVE SIMPLE
EN ACIER INOXYDABLE



DIMENSIONS

27" x 18" x 9"

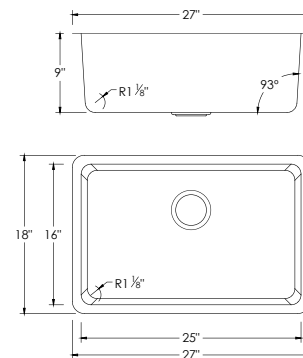

ACCESSOIRE INCLUS



ST-05
CRÉPINE

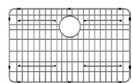

G-406
GRILLE

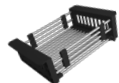

A-911
PANIER



A-916DG
TAPIS DE SÉCHAGE



A-904
PLANCHE À DÉCOUPER

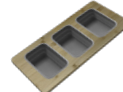

A-910
PLATEAU DE SERVICE



A-913
PLANCHE À DÉCOUPER



A-900DG
SÉCHOIR



S-01S
DISTRIBUTEUR DE SAVON

ACCESSOIRES RECOMMANDÉS

FINITION DE LA SURFACE

FINI SATINÉ
BROSSÉ

DIMENSION DE L'ORIFICE DU DRAIN



PROFILÉ D'ANGLE



RAYON 30mm

INSULATION

TAMPONS ENROBES
+
EN CAOUTCHOUC

PROFONDEUR DE LA CUVE



9"
CUVE
SIMPLE

OPTIONS D'INSTALLATION



SOUS LE COMPTOIR ENCASTRÉ

MATÉRIEL

Acier inoxydable de première qualité de calibre 18 avec teneur en chrome-nickel 18/10. La teneur en chrome de 18 % assure une durabilité, une protection maximale contre la rouille et une belle finition satinée.

La teneur en nickel de 10 % offre une excellente solidité et résistance.



DIMENSIONS DU PRODUIT

Dimensions Hors Tout	27" x 18" x 9"
Dimensions Intérieures	25" x 16" x 9"
Cuve Gauche	-
Cuve Droite	-
Taille d'ouverture du Drain	3 1/2"

CRÉPINE STANDARD

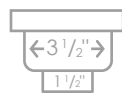

TAILLE DE L'ARMOIRE

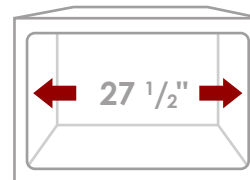

TAILLE MINIMALE DE CAISSON INTERNE

ÉLIMINATION DES DÉCHETS

Les éviers Stylish® possèdent une ouverture de siphon de 3 1/2" pouvant s'adapter à n'importe quel dispositif d'élimination des déchets. La structure de l'évier est bien conçue pour supporter tous les dispositifs d'élimination des déchets.



GARANTIE

Ce produit est couvert par une garantie à vie limitée. Consultez notre site internet pour obtenir tous les détails.

ENTRETIEN

Rincez et séchez votre évier avec un chiffon doux et propre, en veillant à frotter dans le sens du grain. Nous recommandons l'utilisation d'un doux mélange d'eau et de vinaigre pour éliminer les dépôts de minéraux qui peuvent éventuellement s'accumuler sur votre évier.

Utilisez des crèmes nettoyantes liquides non abrasives qui ne contiennent pas de chlore, d'hypochlorite de sodium ou d'acide chlorhydrique pour aider à conserver l'aspect original de votre évier. Assurez-vous de bien rincer votre évier et de l'essuyer. Nous recommandons l'utilisation d'une grille en acier inoxydable qui s'insère au fond de l'évier et le protège des rayures.

NORMES CONFORMES

Cet évier est conforme aux normes CUPC. La crépine ST-05 est certifiée CUPC par l'usine.



Stylish International Inc.

www.stylishkb.com

[stylish.international.inc](https://www.instagram.com/stylish.international.inc)

care@stylishkb.com

+1-855-789-5352